

MOS FIELD EFFECT TRANSISTOR
2SK2410

SWITCHING
 N-CHANNEL POWER MOS FET
 INDUSTRIAL USE

DESCRIPTION

The 2SK2410 is N-Channel MOS Field Effect Transistor designed for high speed switching applications.

FEATURES

- Low On-Resistance
 $R_{DS(on)1} = 40 \text{ m}\Omega \text{ MAX. (@ } V_{GS} = 10 \text{ V, } I_D = 15 \text{ A)}$
 $R_{DS(on)2} = 60 \text{ m}\Omega \text{ MAX. (@ } V_{GS} = 4 \text{ V, } I_D = 15 \text{ A)}$
- Low C_{iss} $C_{iss} = 1500 \text{ pF TYP.}$
- High Avalanche Capability Ratings
- Built-in G-S Gate Protection Diodes

QUALITY GRADE

Standard

Please refer to "Quality grade on NEC Semiconductor Devices" (Document number IEI-1209) published by NEC Corporation to know the specification of quality grade on the devices and its recommended applications.

ABSOLUTE MAXIMUM RATINGS (TA = 25 °C)

Drain to Source Voltage	V_{DSS}	60	V
Gate to Source Voltage	V_{GSS}	± 20	V
Drain Current (DC)	$I_{D(DC)}$	± 30	A
Drain Current (pulse)*	$I_{D(pulse)}$	± 120	A
Total Power Dissipation (Tc = 25 °C)	P_{T1}	35	W
Total Power Dissipation (TA = 25 °C)	P_{T2}	2.0	W
Channel Temperature	T_{ch}	150	°C
Storage Temperature	T_{stg}	-55 to +150	°C
Single Avalanche Current**	I_{AS}	30	A
Single Avalanche Energy**	E_{AS}	90	mJ

* $PW \leq 10 \mu s$, Duty Cycle $\leq 1 \%$

** Starting $T_{ch} = 25 \text{ }^\circ\text{C}$, $R_G = 25 \text{ }\Omega$, $V_{GS} = 20 \text{ V} \rightarrow 0$

PACKAGE DIMENSIONS

(in millimeters)

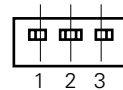
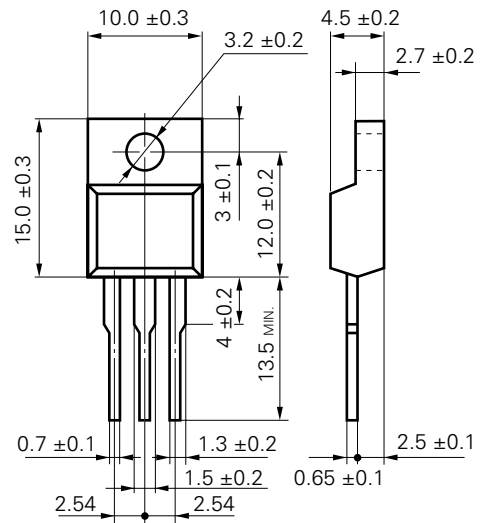

1. Gate
2. Drain
3. Source

MP-45F (ISOLATED TO-220)

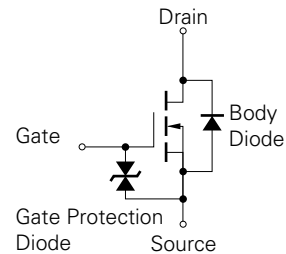

The information in this document is subject to change without notice.

ELECTRICAL CHARACTERISTICS (T_A = 25 °C)

CHARACTERISTIC	SYMBOL	MIN.	TYP.	MAX.	UNIT	TEST CONDITIONS
Drain to Source On-Resistance	R _{DS(on)1}		31	40	mΩ	V _{GS} = 10 V, I _D = 15 A
Drain to Source On-Resistance	R _{DS(on)2}		40	60	mΩ	V _{GS} = 4 V, I _D = 15 A
Gate to Source Cutoff Voltage	V _{GS(off)}	1.0	1.5	2.0	V	V _{DS} = 10 V, I _D = 1 mA
Forward Transfer Admittance	y _{fs}	15	27		S	V _{DS} = 10 V, I _D = 15 A
Drain Leakage Current	I _{bss}			10	μA	V _{DS} = 60 V, V _{GS} = 0
Gate to Source Leakage Current	I _{gss}			±10	μA	V _{GS} = ±20 V, V _{DS} = 0
Input Capacitance	C _{iss}		1500		pF	V _{DS} = 10 V
Output Capacitance	C _{oss}		720		pF	V _{GS} = 0
Reverse Transfer Capacitance	C _{rss}		190		pF	f = 1 MHz
Turn-On Delay Time	t _{d(on)}		22		ns	I _D = 15 A
Rise Time	t _r		260		ns	V _{GS(on)} = 10 V
Turn-Off Delay Time	t _{d(off)}		130		ns	V _{DD} = 30 V
Fall Time	t _f		150		ns	R _G = 10 Ω
Total Gate Charge	Q _G		50		nC	I _D = 30 A
Gate to Source Charge	Q _{GS}		5.0		nC	V _{DD} = 48 V
Gate to Drain Charge	Q _{GD}		15		nC	V _{GS} = 10 V
Body Diode Forward Voltage	V _{F(S-D)}		1.1		V	I _F = 30 A, V _{GS} = 0
Reverse Recovery Time	t _{rr}		110		ns	I _F = 30 A, V _{GS} = 0
Reverse Recovery Charge	Q _{rr}		320		nC	di/dt = 100 A/μs

Test Circuit 1 Avalanche Capability

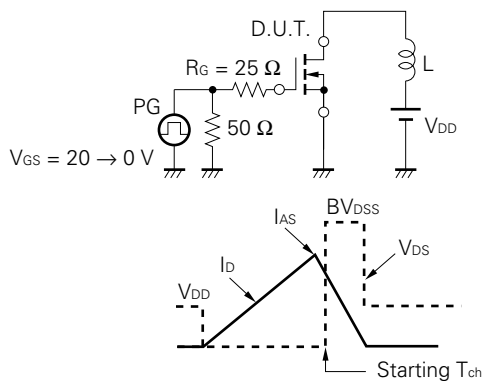

Test Circuit 2 Switching Time

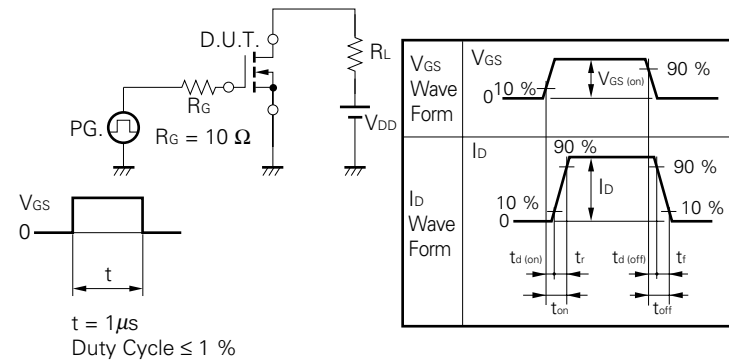

Test Circuit 3 Gate Charge

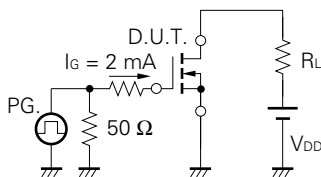

The application circuits and their parameters are for references only and are not intended for use in actual design-in's.

TYPICAL CHARACTERISTICS (T_A = 25 °C)

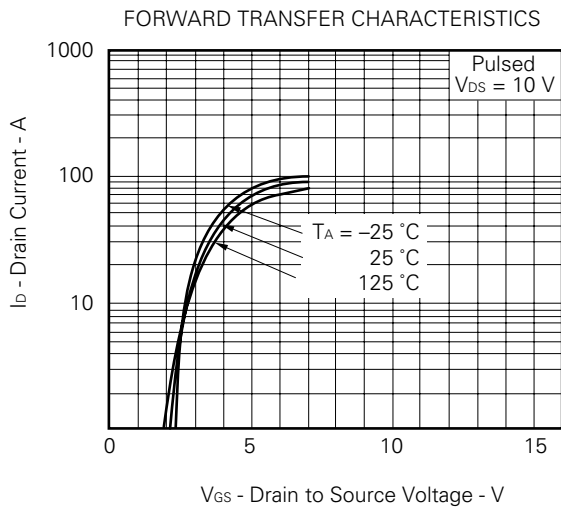
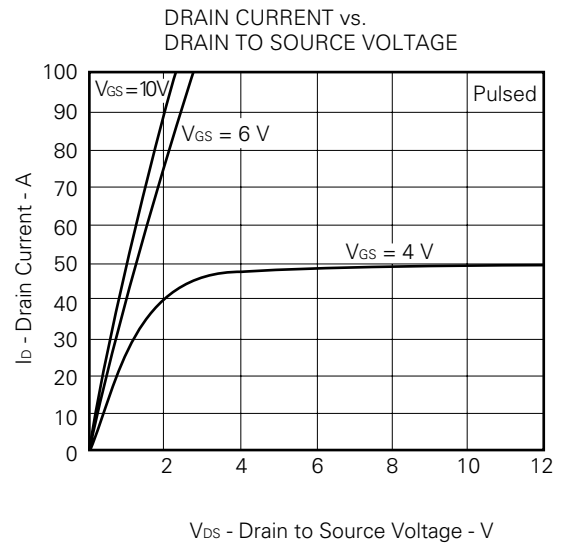
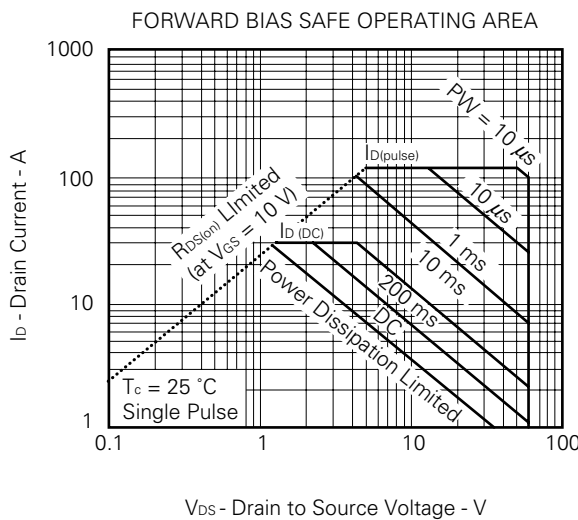
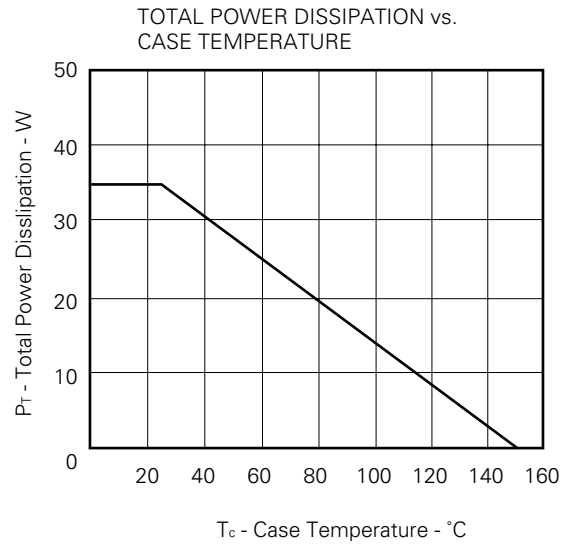
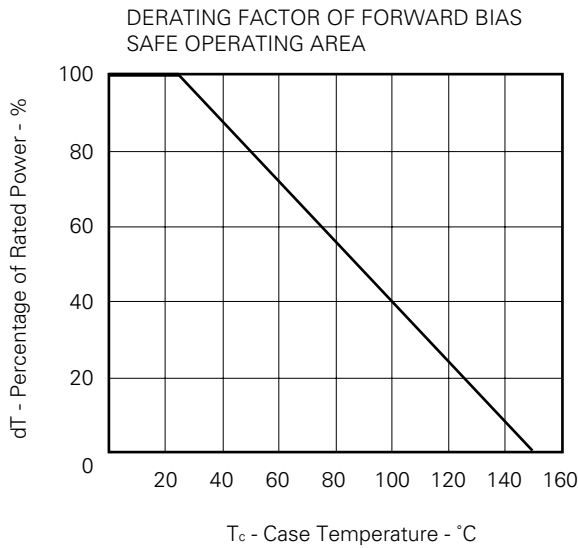

TRANSIENT THERMAL RESISTANCE vs. PULSE WIDTH

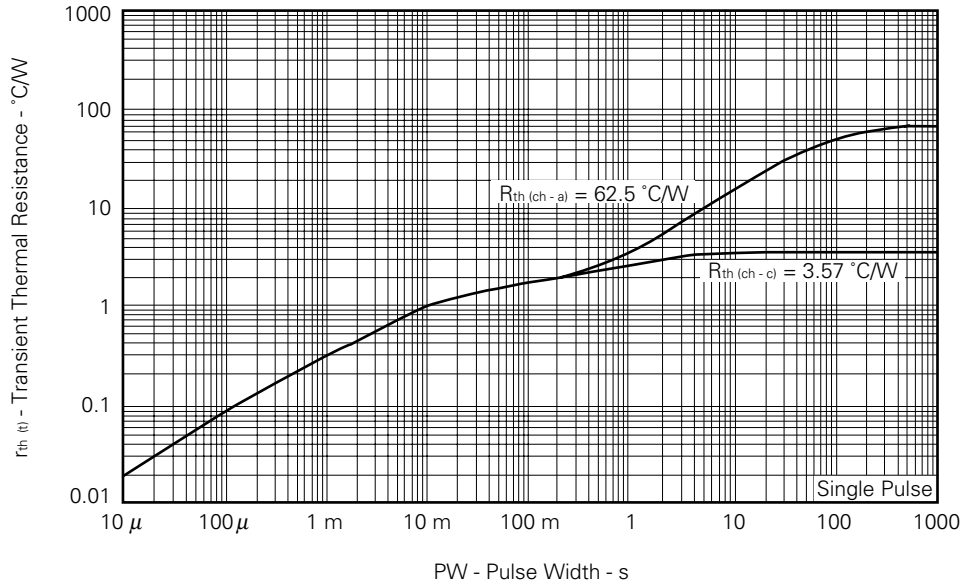

FORWARD TRANSFER ADMITTANCE vs. DRAIN CURRENT

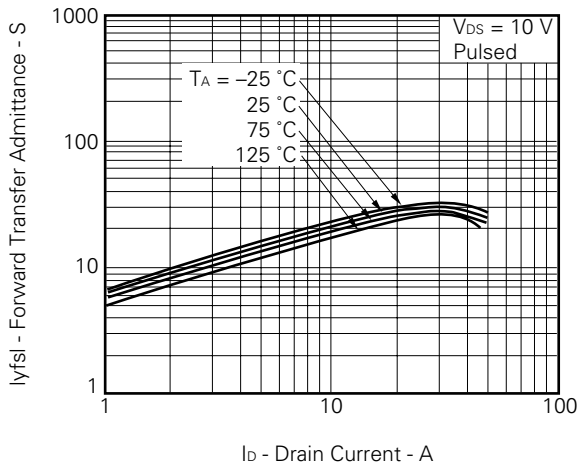

DRAIN TO SOURCE ON-STATE RESISTANCE vs. GATE TO SOURCE VOLTAGE

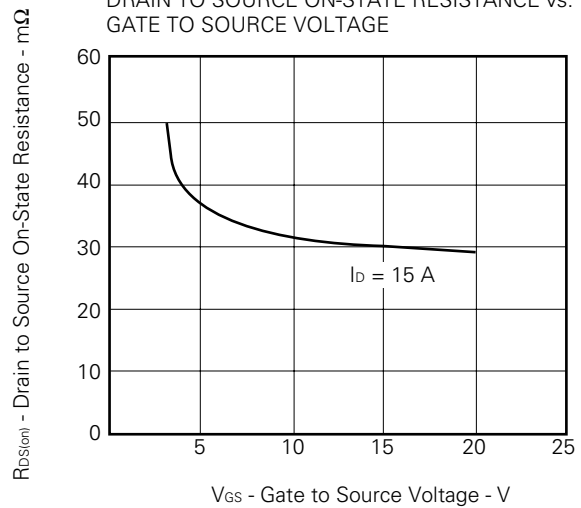

DRAIN TO SOURCE ON-STATE RESISTANCE vs. DRAIN CURRENT

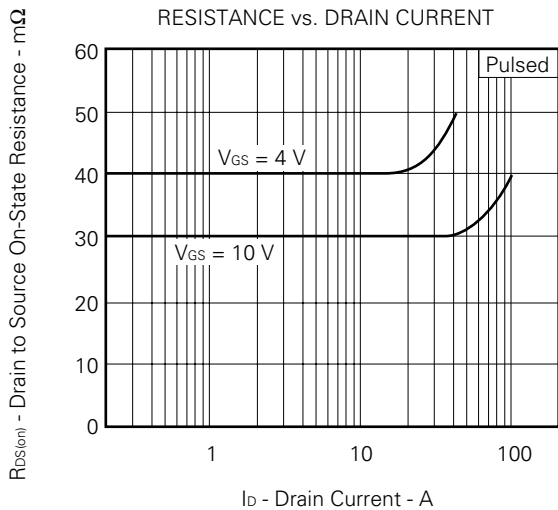

GATE TO SOURCE CUTOFF VOLTAGE vs. CHANNEL TEMPERATURE

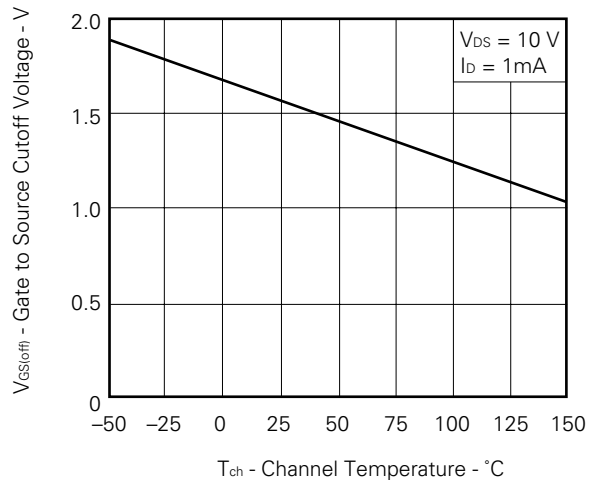

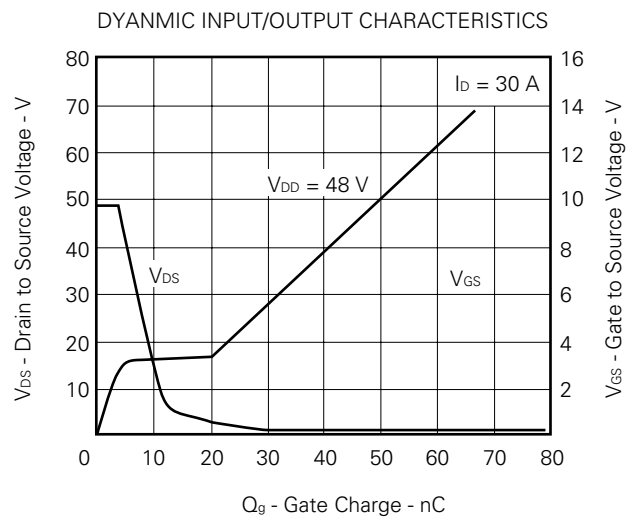
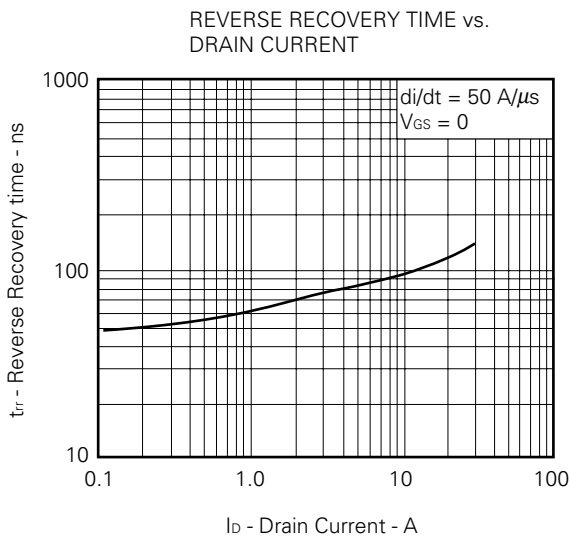
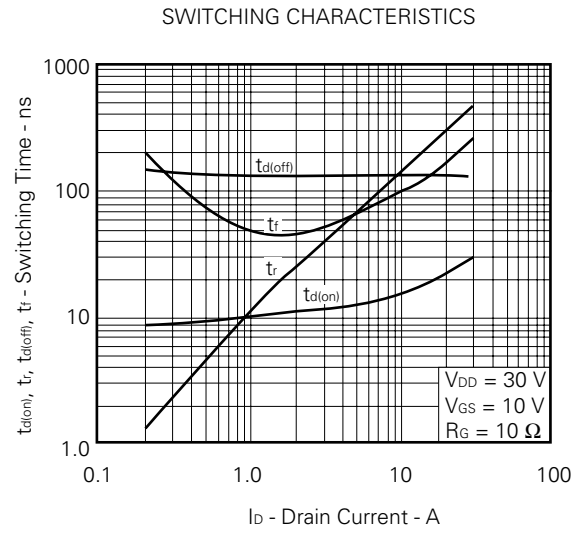
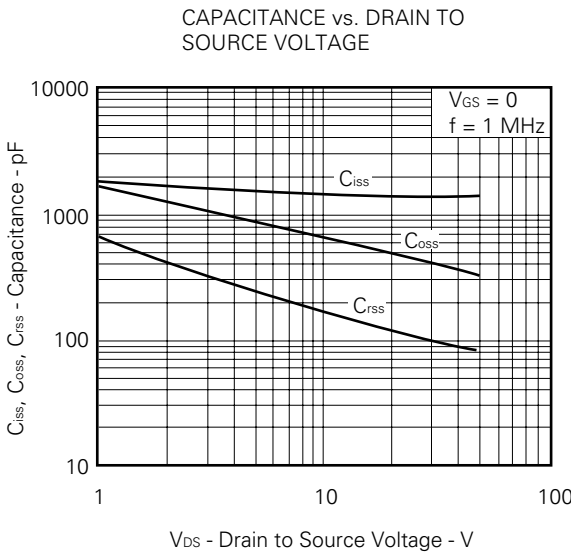
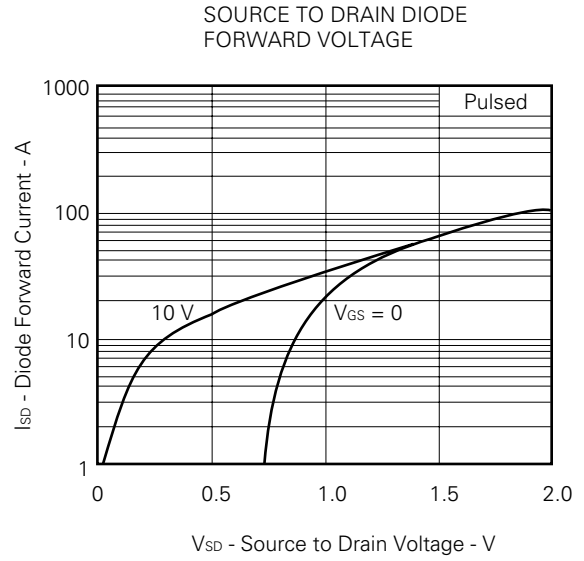
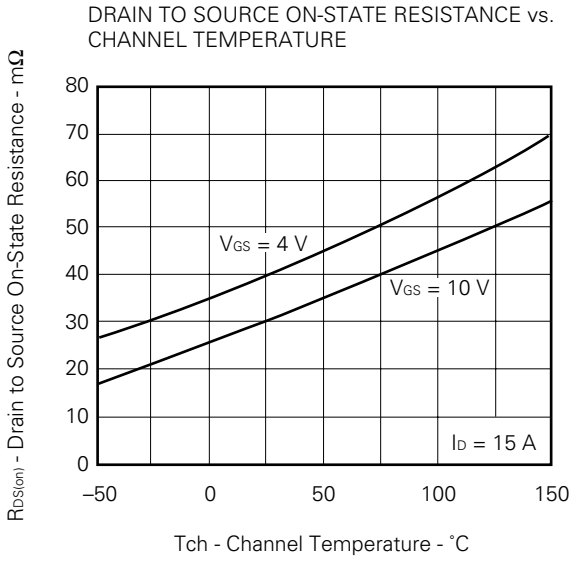

SINGLE AVALANCHE ENERGY vs. INDUCTIVE LOAD

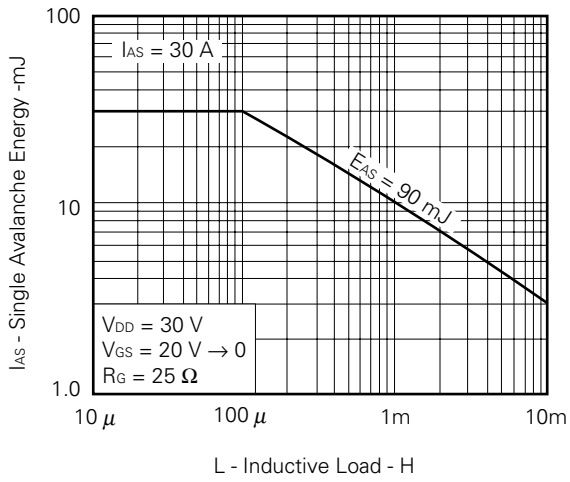

SINGLE AVALANCHE ENERGY DERATING FACTOR

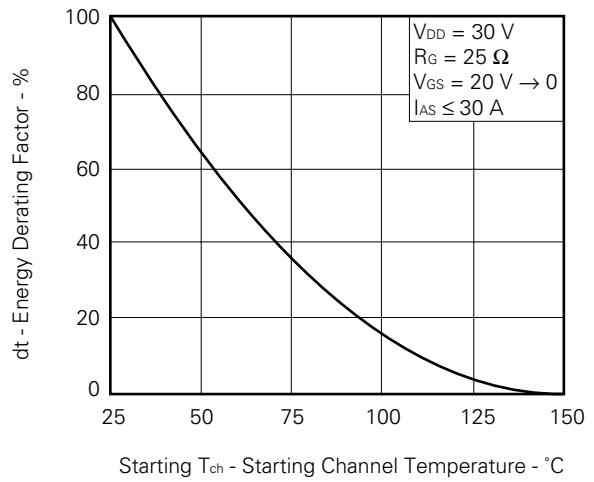

REFERENCE

Document Name	Document No.
NEC semiconductor device reliability/quality control system.	TEI-1202
Quality grade on NEC semiconductor devices.	IEI-1209
Semiconductor device mounting technology manual.	IEI-1207
Semiconductor device package manual.	IEI-1213
Guide to quality assurance for semiconductor devices.	MEI-1202
Semiconductor selection guide.	MF-1134
Power MOS FET features and application switching power supply.	TEA-1034
Application circuits using Power MOS FET.	TEA-1035
Safe operating area of Power MOS FET.	TEA-1037

The diode connected between the gate and source of the transistor serves as a protector against ESD. When this device is actually used, an additional protection circuit is externally required if a voltage exceeding the rated voltage may be applied to this device.

[MEMO]

No part of this document may be copied or reproduced in any form or by any means without the prior written consent of NEC Corporation. NEC Corporation assumes no responsibility for any errors which may appear in this document.

NEC Corporation does not assume any liability for infringement of patents, copyrights or other intellectual property rights of third parties by or arising from use of a device described herein or any other liability arising from use of such device. No license, either express, implied or otherwise, is granted under any patents, copyrights or other intellectual property rights of NEC Corporation or others.

The devices listed in this document are not suitable for use in aerospace equipment, submarine cables, nuclear reactor control systems and life support systems. If customers intend to use NEC devices for above applications or they intend to use "Standard" quality grade NEC devices for applications not intended by NEC, please contact our sales people in advance.

Application examples recommended by NEC Corporation

Standard: Computer, Office equipment, Communication equipment, Test and Measurement equipment, Machine tools, Industrial robots, Audio and Visual equipment, Other consumer products, etc.

Special: Automotive and Transportation equipment, Traffic control systems, Antidisaster systems, Anticrime systems, etc.